

# ReVent <sup>TM</sup> ▶

models #RVS50, RVS70,  
RVS80, RVS90, RVS110,  
RVS130, RVS150

## Installation Guide

Read and Save These Instructions

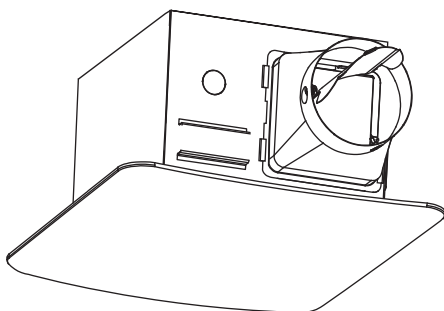

**Need Help?**

Watch the installation video at:  
**[reventfans.com/install](http://reventfans.com/install)**

Questions? Call  
1-877-543-8698 (English) or  
1-800-615-5439 (French)

# Please Read and Save These Instructions

## Table of Contents

page 1 .....	Table of Contents
page 1-2 .....	Specifications
page 3 .....	What's Inside The Box
page 4 .....	Safety Information
page 5 .....	Planning Your Installation
page 6 .....	Connecting The Duct
page 7 .....	Removing Your Old Fan
page 8-13 .....	SheetLock™ Easy Roomside Installation
page 14-19 .....	Installation For New Construction Framing
page 19 .....	Care And Cleaning
page 20 .....	Frequently Asked Questions
page 21 .....	3-Year Limited Warranty

## Specifications

### **RVS50, RVS70, RVS80**

Duct Exhaust Diameter	4 in ( 10.2 cm )
Voltage	120 V
Frequency	60 Hz
Fan Watts	13 W, 16 W, 20 W
Air Flow	50 CFM, 70 CFM, 80 CFM
Fan Weight	5.25 Lbs ( 2.4 Kg )
Sound	0.3 Sone, 0.7 Sone, 0.8 Sone
Grille Size	11 x 11 in ( 27.9 x 27.9 cm )
Housing Length*	8 <sup>3</sup> / <sub>8</sub> " in ( 21.3 cm )
Housing Width*	7 <sup>7</sup> / <sub>8</sub> " in ( 20 cm )
Housing Depth*	5 <sup>1</sup> / <sub>8</sub> " in ( 13 cm )

\*This may require modification of your current opening. Some hand tools required. Power tools may also be necessary.

## RVS90, RVS110

Duct Exhaust Diameter	4 in ( 10.2 cm )
Voltage	120 V
Frequency	60 Hz
Fan Watts	23 W, 30 W
Air Flow	90 CFM, 110 CFM
Fan Weight	6.95 Lbs ( 3.15 Kg )
Sound	0.7 Sone, 1.3 Sone
Grille Size	12 <sup>5</sup> / <sub>8</sub> " x 12 <sup>5</sup> / <sub>8</sub> " in ( 32.1 x 32.1 cm )
Housing Length*	9 <sup>3</sup> / <sub>4</sub> " in ( 24.8 cm )
Housing Width*	9 <sup>1</sup> / <sub>2</sub> " in ( 24.1 cm )
Housing Depth*	6 <sup>3</sup> / <sub>8</sub> " in ( 16.2 cm )

\*This may require modification of your current opening. Some hand tools required. Power tools may also be necessary.

## RVS130, RVS150

Duct Exhaust Diameter	6 in ( 15.24 cm )
Voltage	120 V
Frequency	60 Hz
Fan Watts	34 W, 40 W
Air Flow	130 CFM, 150 CFM
Fan Weight	8.6 Lbs ( 3.9 Kg )
Sound	1.5 Sone, 1.5 Sone
Grille Size	13 <sup>3</sup> / <sub>8</sub> " x 13 <sup>3</sup> / <sub>8</sub> " in ( 34 x 34 cm )
Housing Length*	10 <sup>1</sup> / <sub>2</sub> " in ( 26.7 cm )
Housing Width*	10 <sup>3</sup> / <sub>8</sub> " in ( 26.4 cm )
Housing Depth*	7 <sup>5</sup> / <sub>8</sub> " in ( 19.4 cm )

\*This may require modification of your current opening. Some hand tools required. Power tools may also be necessary.

# What's Inside The Box

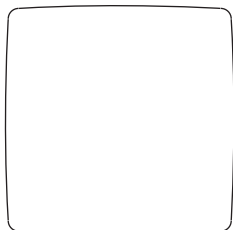

**GRILLE**  
Qty:1

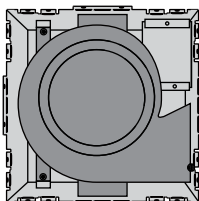

**FAN**  
Qty:1

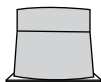

**DAMPER**  
Qty:1

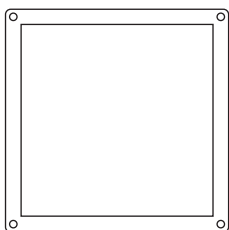

**TRIM RING**  
Qty:1

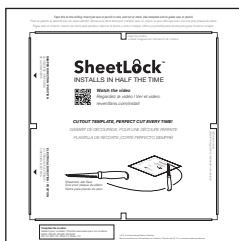

**TEMPLATE**  
Qty:1



**MANUAL**  
Qty:1



**LONG BRACKET**  
(used for new construction only)  
Qty:1



**SHORT BRACKET**  
(used for new construction only)  
Qty:2

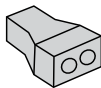

**2-WIRE QUICK CONNECT**  
Qty:2  
(U.S.A. only)

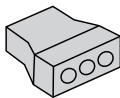

**3-WIRE QUICK CONNECT**  
Qty:1  
(U.S.A. only)



**ROUNDHEAD WOOD SCREW**  
(used for new construction only)  
Qty:6



**1/2" x #6 BRACKET SECURING SCREW**  
(used for new construction only)  
Qty:3



**6 TO 4 IN DUCT ADAPTER**  
(only included with 130 or 150 CFM models)  
Qty:1



**WIRE NUT**  
Qty:3  
(Canada only)

# Safety Information

1.) **WARNING - TO REDUCE THE RISK OF FIRE, ELECTRIC SHOCK, OR INJURY TO PERSONS, OBSERVE THE FOLLOWING:**

- a) Installation work and electrical wiring must be done by qualified person(s) in accordance with all applicable codes and standards, including fire-rated construction.
  - b) Sufficient air is needed for proper combustion and exhausting of gases through the flue (chimney) of fuel burning equipment to prevent back drafting. Follow the heating equipment manufacturer's guideline and safety standards, such as those published by the National Fire Protection Association (NFPA), the American Society for Heating, Refrigeration and Air Conditioning Engineers (ASHRAE), and the local code authorities.
  - c) When cutting or drilling into wall or ceiling, do not damage electrical wiring and other hidden utilities.
  - d) Ducted fans must always be vented to the outdoors.
  - e) If this unit is to be installed over a tub or shower, it must be marked as appropriate for the application and be connected to a GFCI (Ground Fault Circuit Interrupter) - protected branch circuit.
- 2.) Use this unit only in the manner intended by the manufacturer. If you have questions, contact the manufacturer.
- 3.) Before servicing or cleaning unit, switch power off at service panel and lock the service disconnecting means to prevent power from being switched on accidentally. When the service disconnecting means cannot be locked, securely fasten a prominent warning device, such as a tag, to the service panel.
- 4.) This ventilation fan is approved for use over a bathtub or shower when installed in a GFCI protected circuit. Do not use unapproved fans over a bathtub or shower that are not approved for that application.
- 5.) Install ductwork in a straight line with minimal bends.
- 6.) Use 120 V, 60 Hz for the electrical supply and properly ground the unit. Follow all local safety and electrical codes.
- 7.) Do not use this fan with any solid-state control device; such as a dimmer switch. Solid-state controls may cause harmonic distortion, which can cause a motor humming noise, as well as increase risk of fire or electric shock.
- 8.) To reduce the risk of fire or electric shock, do not block air entry grille.
- 9.) Mount with the lowest moving parts at least 8.2 ft (2.5 m) above floor or grade level.
- 10.) **Never** place a switch where it can be reached from a tub or shower.
- 11.) Not to be installed in a ceiling thermally insulated to a value greater than R50. (This is required for installation in Canada only).
- 12.) Not for use in cooking areas. (See PAGE 5 for details)
- 13.) This product must properly connect to the grounding conductor of the supply circuit.

Follow the heating equipment manufacturer's guideline and safety standards, such as those published by the National Fire Protection Association (NFPA), the American Society for Heating, Refrigeration and Air Conditioning Engineers (ASHRAE), and the local code authorities.



**WARNING:** Not suitable for use as a range hood.



**CAUTION:** For General Ventilating Use Only - Do Not Use To Exhaust Hazardous Or Explosive Materials And Vapors.



**CAUTION:** Do not install in locations where the temperature will exceed 104°F (40°C).



**IMPORTANT:** Exercise care to not damage existing wiring when cutting or drilling into walls or ceilings.



**NOTE:** Make sure duct work size is a minimum of the discharge. Do not reduce. Reducing the duct size can increase fan noise.



**IMPORTANT:** You may want to consult with a qualified licensed electrician regarding the wiring of your ventilation fan.



**WARNING:** To reduce the risk of electric shock, please disconnect the electrical supply circuit before servicing.



**CAUTION:** This product must be properly grounded.

**Go to [reventfans.com](http://reventfans.com) to obtain a copy of this manual.**

# Planning Your Installation

When installing the ventilation fan in a new construction site, install the main body of the FAN and duct work during the rough-in construction of the building. The GRILLE should be installed after the finished ceiling is in place.

When installing in existing construction, use the provided cutout TEMPLATE for the ceiling. GRILLE edge should overlap finished ceiling.

Not for use in cooking area - see diagram below.

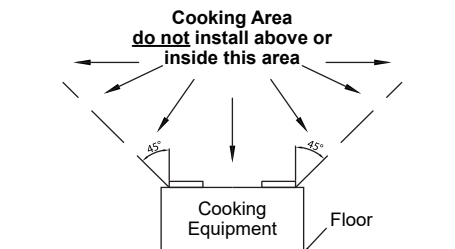

Do not install ventilation fan in areas where the duct work will require configuration as shown.

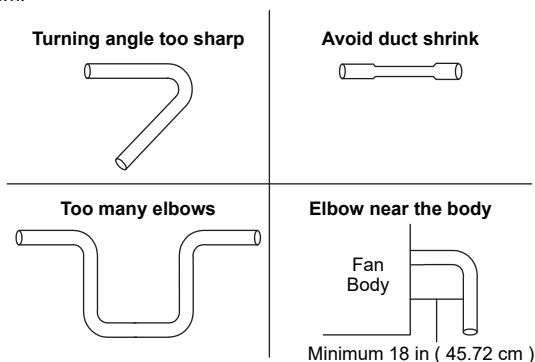

 **NOTE:** If installing in existing construction, you may need to have access to space above and below the installation location.

There are multiple installation configurations possible for this ventilation fan. Not all configurations are shown. If your installation requires a variation other than those shown, consult with a licensed contractor to determine the best installation for your project. If you are replacing an existing fan, ensure that the new FAN will adequately cover the existing opening.

# Connecting the Duct

- Install a circular duct to outlet and secure it with duct tape or clamps.
- Install the duct to the outlet with a gradient  $1^{\circ}\sim 2^{\circ}$  to the outside as shown.
- The ducting from this FAN to the outside of the building has a strong effect on the air flow, noise and energy use of the fan. Use the shortest, straightest duct routing possible for best performance, and avoid installing the FAN with smaller ducts than recommended. Insulation around the ducts can reduce energy loss and inhibit mold growth. Fans installed with existing ducts may not achieve their rated airflow.
- For models RVS50, RVS70, RVS80, RVS90, or RVS110, 4 in (10.16 cm) round is recommended for best performance. For models RVS130 or RVS150, 6 in (15.24 cm) round is recommended for best performance.
- Ensure duct joints and exterior penetrations are sealed with caulk or other similar material to create an air-tight path, to minimize building heat loss and gain, and to reduce the potential for condensation.
- Place/wrap insulation around duct and/or FAN in order to minimize possible condensation buildup within the duct, building heat loss and gain.

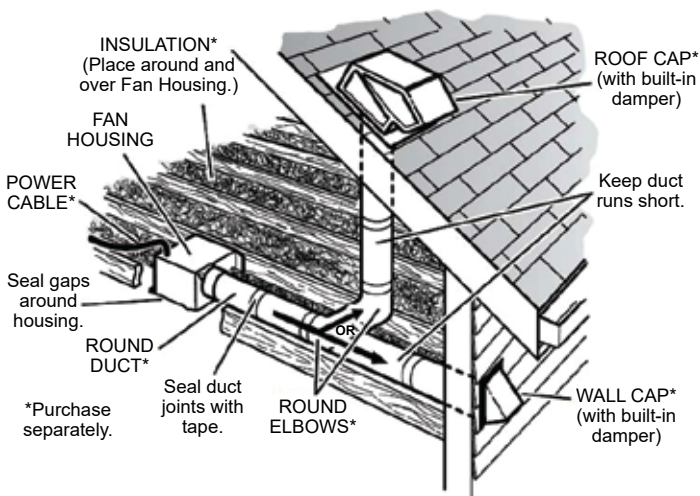

# Removing Your Old Fan

**1.) Disconnect the electrical power supply and lock out the service panel for the existing fan.**

2.) Remove the grille from the existing fan. Pull the grille down to expose it's two springs. Squeeze each spring together and pull down again to release the springs from the motor plate slots.

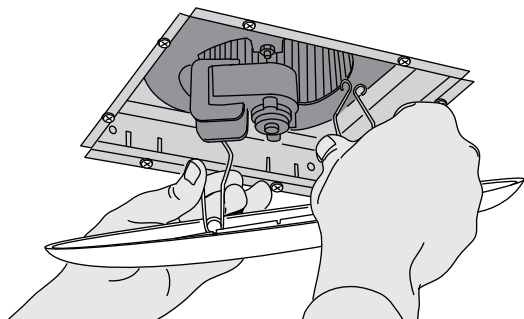

3.) Your existing fan may be attached in several ways. Look for attachment screws in the ceiling and remove. Your fan may also be attached on the attic side, which will require you to access it from the attic. Locate attic attachment screws and remove.

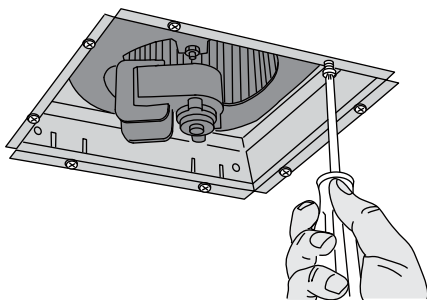

4.) Remove the old fan.

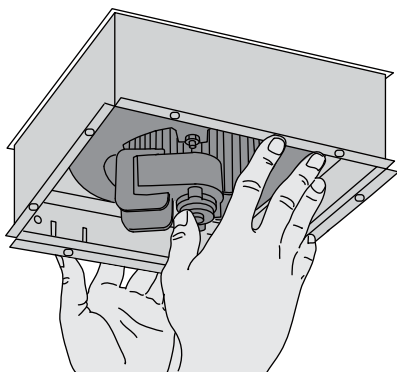



# SheetLock™ Easy Roomside Installation

Watch the video: [REVENTFANS.COM/INSTALL](http://REVENTFANS.COM/INSTALL)

**⚠ WARNING:** Disconnect all AC Power Breakers or Fuses before attempting to cut into your ceiling.

1.) Place the provided sheetrock cutout TEMPLATE on ceiling where you wish the FAN to be (DAMPER and electrical positions shown on TEMPLATE). We suggest using painter's masking tape to hold the template in place while cutting. If there is a pre-existing fan opening, use aligning windows to find it's edges. Either cut through the provided guide slots in the TEMPLATE, or mark your cut lines with a pencil and remove the TEMPLATE. Use a sheetrock jab saw to cut your fan opening in the ceiling.

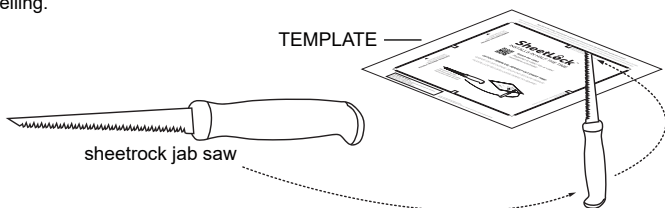

2.) Use a flathead screwdriver to raise the DAMPER away from the notch in the FAN body, then slide the DAMPER up half way until the notch in the side of the DAMPER aligns with the upper set of guides. Remove the DAMPER from the FAN.

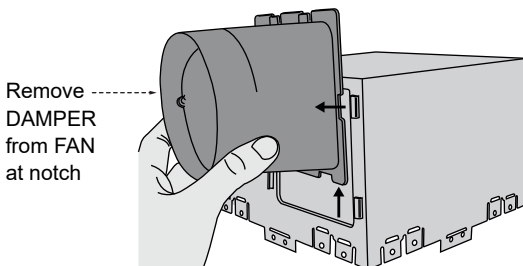
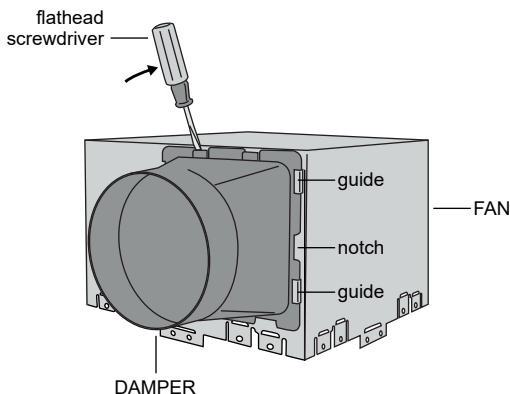

3.) Attach DAMPER to ducting. Tape DAMPER to ducting with duct tape. Set the connected DAMPER and ducting in the ceiling opening, then set the FAN in the ceiling opening as well.

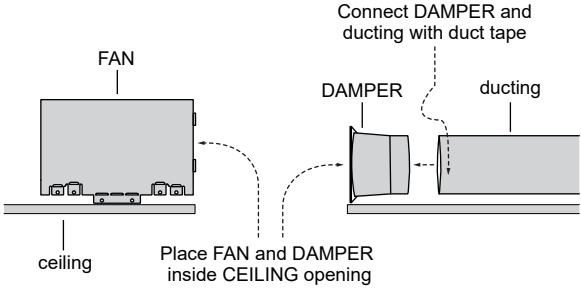

4.) Attach conduit with wiring to FAN.

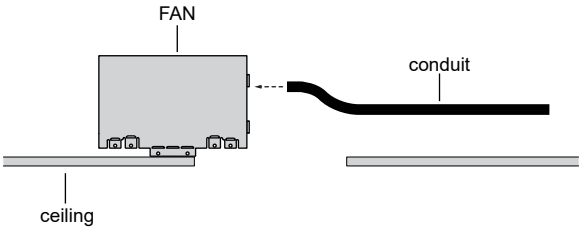

5.) Reattach DAMPER to FAN inside the ceiling, damper should click into place securely.

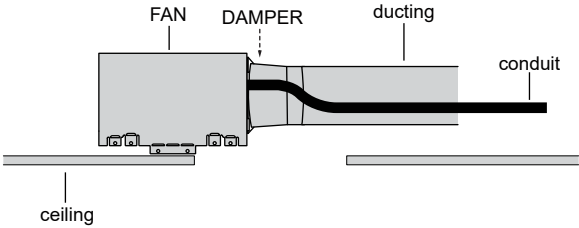

6.) Select a set of holding tabs, depending on the thickness of your sheetrock.

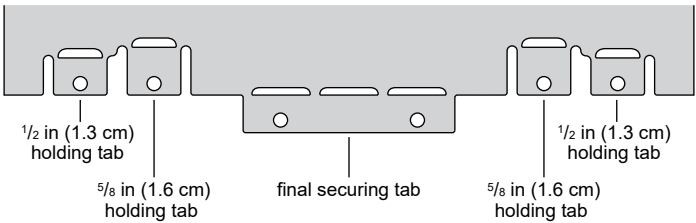

7.) Bend the holding tabs you selected outward.

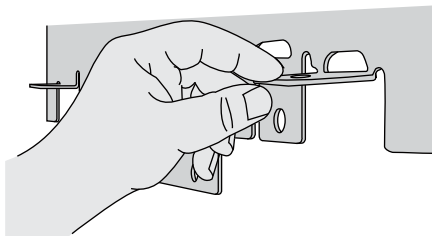

8.) Set FAN into place in the opening using holding tabs, now the tabs hold the fan in position in the ceiling opening.

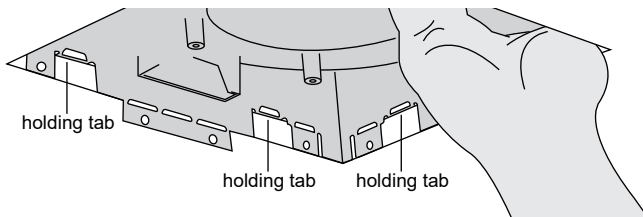

**⚠ WARNING:** Disconnect the AC power before any work is done to any part of the circuit ReVent is connected to. If you do not understand this warning, seek the services of a qualified licensed electrician.

**⚠ WARNING:** Copper to copper only. Do **not** use aluminum wire.

**⚠ WARNING:** Follow all local electrical and safety codes, and NEC (National Electrical Codes).

**⚠ CAUTION:** If your house wires do not match these colors, determine what each house wire represents before connecting. You may need to consult a qualified licensed electrician to determine this safely.

9.) Disconnect FAN motor from electrical enclosure. Remove the electrical cover set screw and slide open the electrical enclosure.

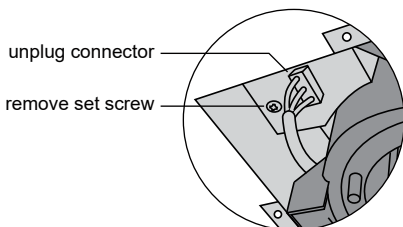

10.) Remove the electrical cover set screw and slide open the electrical enclosure. Connect wiring using the provided QUICK CONNECTS (U.S.A.) or WIRE NUTS (Canada).

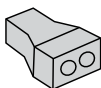

2-WIRE QUICK  
CONNECT  
Qty:2  
(U.S.A. only)

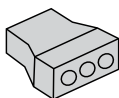

3-WIRE QUICK  
CONNECT  
Qty:1  
(U.S.A. only)

OR



WIRE NUT  
Qty:3  
(Canada only)

Match wire colors as shown:

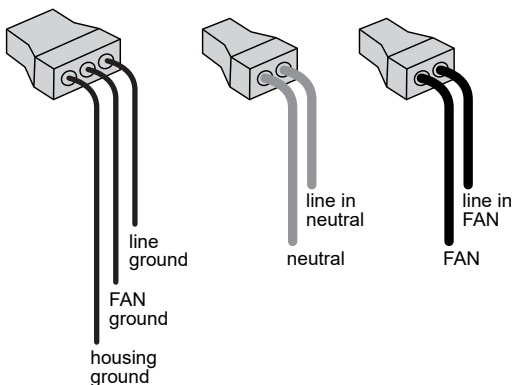

**SWITCH NOT INCLUDED, MUST BE PURCHASED SEPARATELY**

Always follow all safety instructions included with the switch you purchase. Do not exceed maximum electrical ratings.

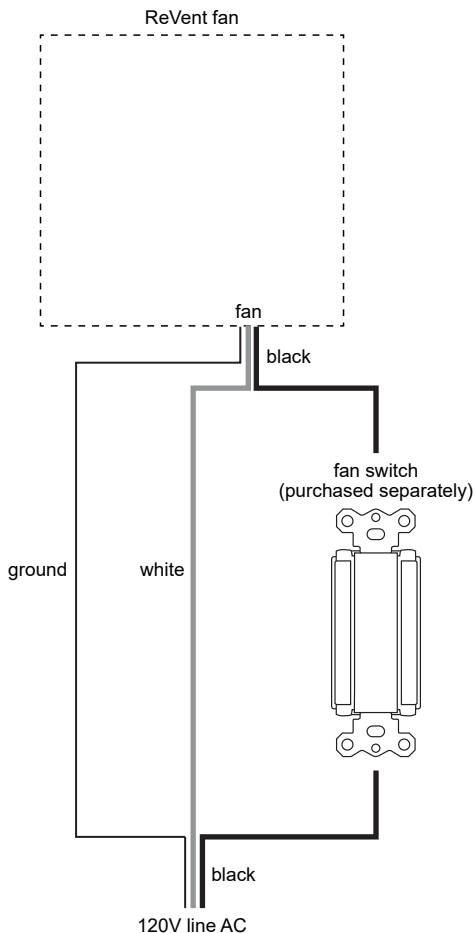

11.) Once connected, reattach the electrical enclosure.

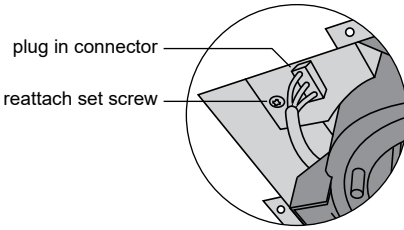

12.) Press and bend the final securing tabs flat against ceiling to lock the FAN in place.

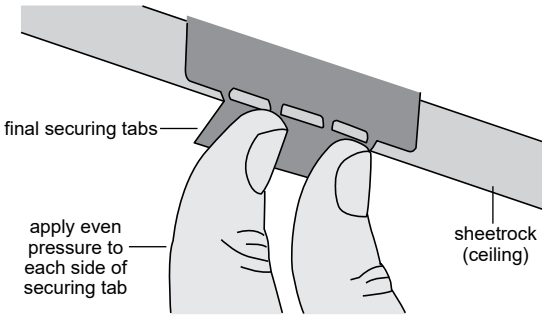

13.) Align TRIM RING notch to vent (DAMPER) position. Attach TRIM RING to FAN. TRIM RING attaches to FAN body and clicks into place when secure.

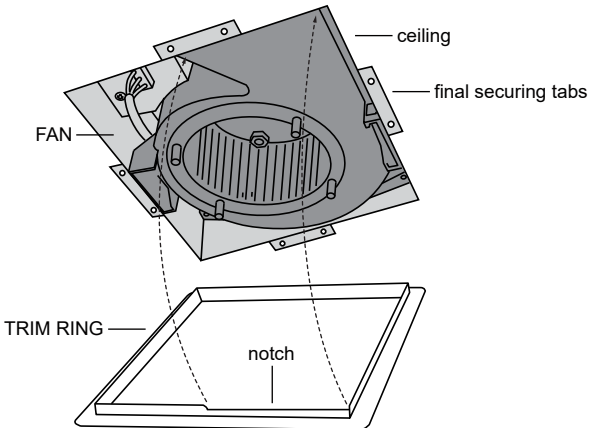

14.) Attach the GRILLE by squeezing the mounting springs together and inserting the springs into the spring guides in the FAN.

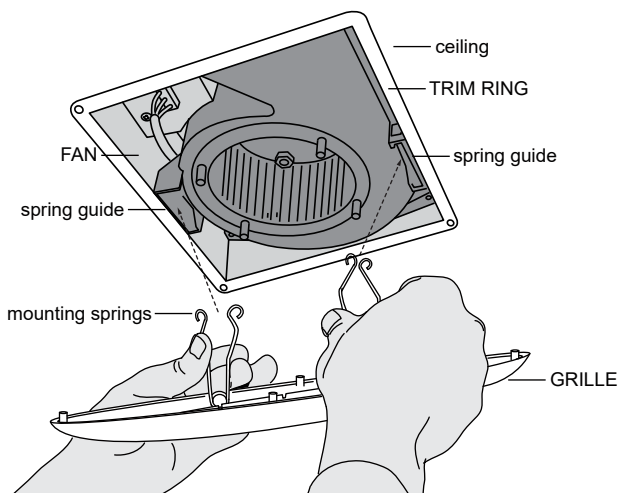

# Installation For New Construction Framing



**NOTE:** Even with new construction, you can use the SheetLock™ installation method; however, ReVent can still be installed using a method home builders would be more familiar with, as outlined in this section.



**WARNING:** Disconnect all AC Power Breakers or Fuses before attempting to cut into your ceiling.

1.) Select a set of holding tabs, depending on the thickness of your sheetrock.

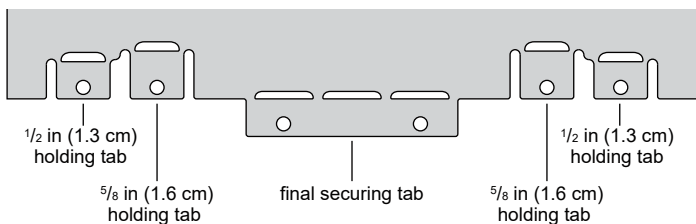

2.) Bend the holding tabs you selected outward.

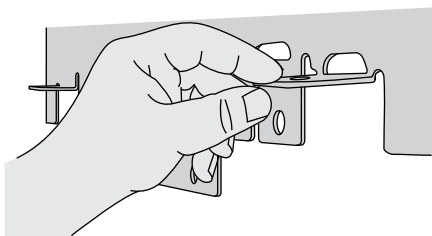

3.) Attach FAN to ceiling joists with BRACKETS using ROUNDHEAD WOOD SCREWS, then install the sheetrock for your ceiling.

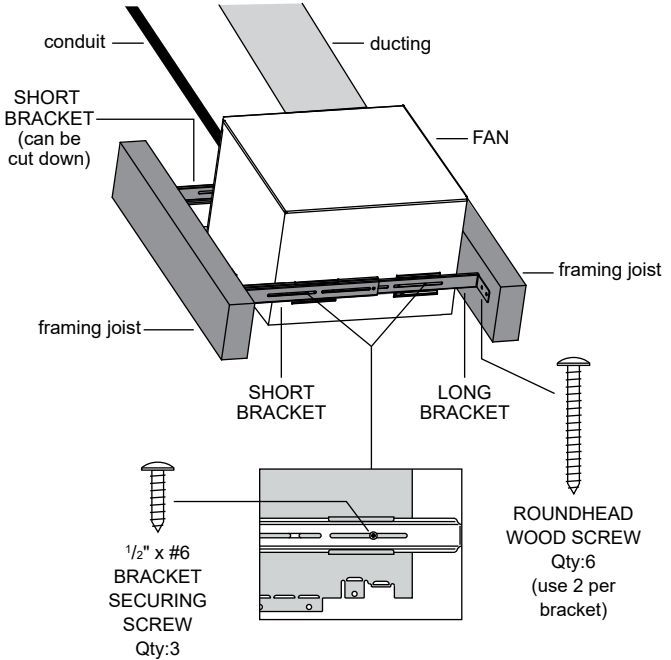



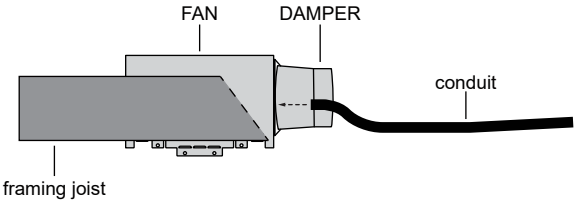

4.) Attach conduit with wiring to FAN.

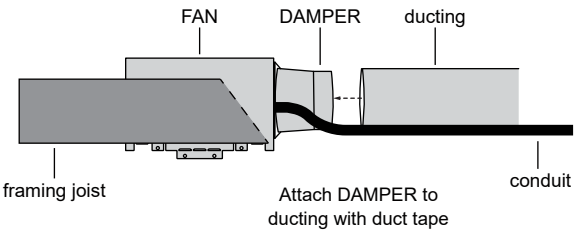

5.) Attach DAMPER to ducting.





-  **WARNING:** Disconnect the AC power before any work is done to any part of the circuit ReVent is connected to. If you do not understand this warning, seek the services of a qualified licensed electrician.
-  **WARNING:** Copper to copper only. Do **not** use aluminum wire.
-  **WARNING:** Follow all local electrical and safety codes, and NEC (National Electrical Codes).
-  **CAUTION:** If your house wires do not match these colors, determine what each house wire represents before connecting. You may need to consult a qualified licensed electrician to determine this safely.

6.) Disconnect FAN motor from electrical enclosure. Remove the electrical cover set screw and slide open the electrical enclosure.

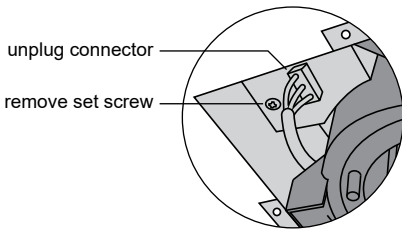

7.) Remove the electrical cover set screw and slide open the electrical enclosure. Connect wiring using the provided QUICK CONNECTS (U.S.A.) or WIRE NUTS (Canada).

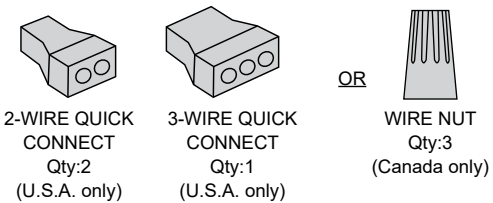

Match wire colors as shown:

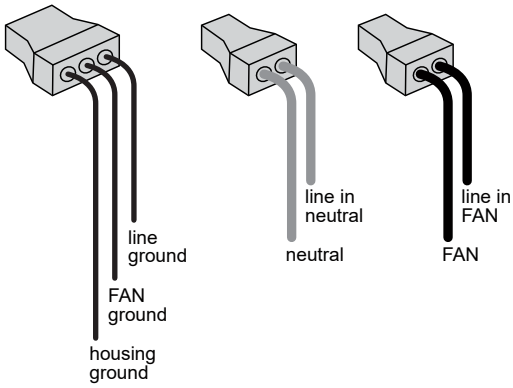

**SWITCH NOT INCLUDED, MUST BE PURCHASED SEPARATELY**

Always follow all safety instructions included with the switch you purchase. Do not exceed maximum electrical ratings.

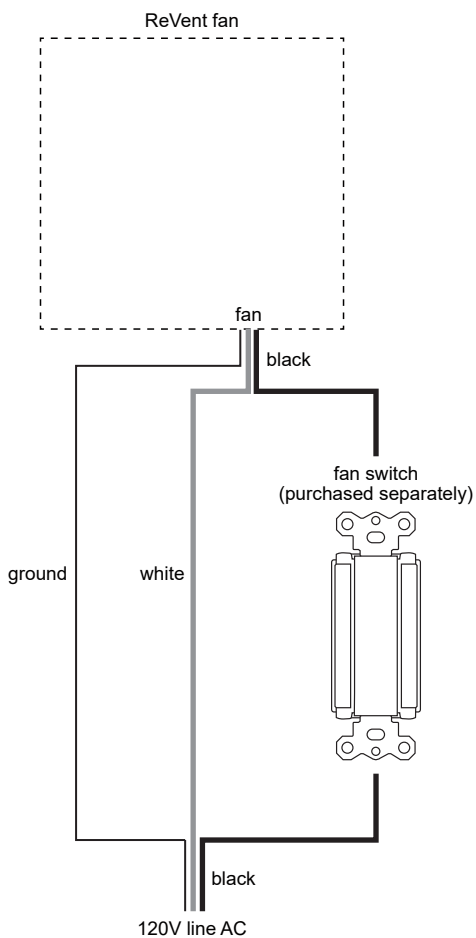

8.) Once connected, reattach the electrical enclosure.

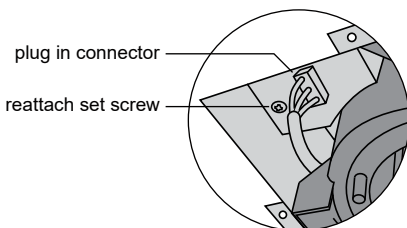

9.) When sheetrock is in place, press and bend the final securing tabs flat against ceiling to lock the FAN in place.

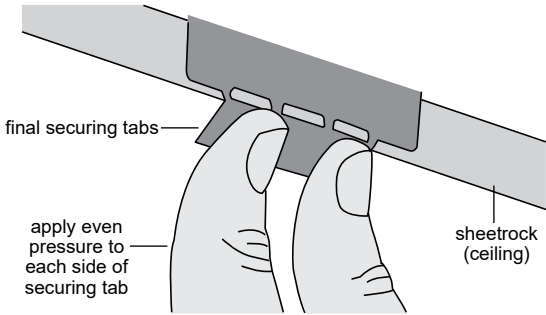

10.) Align TRIM RING notch to vent (DAMPER) position. Attach TRIM RING to FAN. TRIM RING attaches to FAN body and clicks into place when secure.

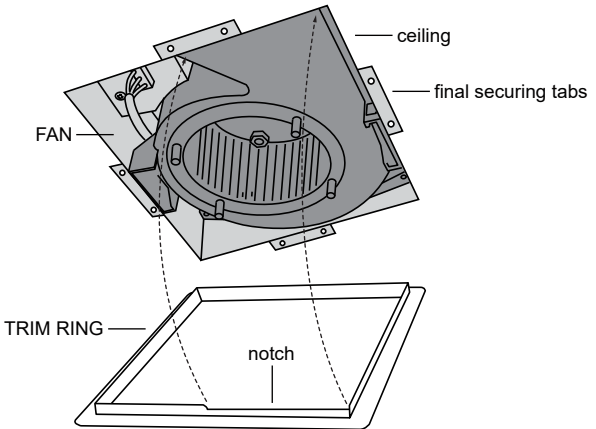

11.) Attach the GRILLE by squeezing the mounting springs together and inserting the springs into the spring guides in the FAN.

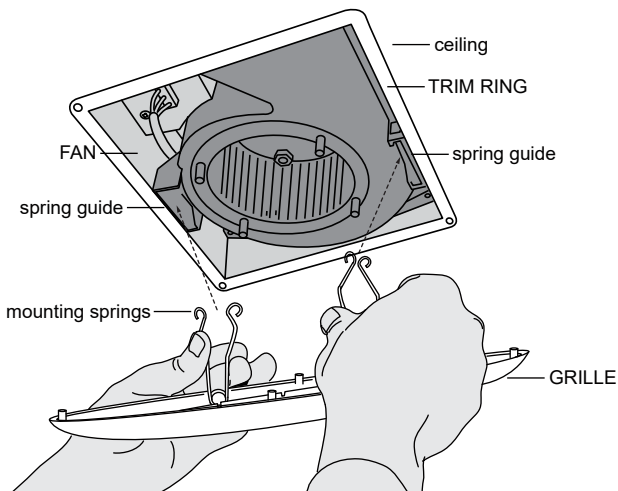

## Care and Cleaning

**⚠ WARNING:** To reduce the risk of electric shock, fire, or injury to persons, disconnect or turn off the breaker and lock the power supply at the panel to prevent the power from being turned on before servicing or cleaning the unit.

- 1.) Remove the GRILLE by squeezing the springs and pulling down.
- 2.) Remove dust and dirt from the FAN with a vacuum cleaner.
- 3.) Dampen cloth with dish detergent. Wipe the FAN and dry with a cloth.
- 4.) Replace the GRILLE.

# Frequently Asked Questions

Q: How do I clean my FAN?

A: It's important to clean the GRILLE cover from time to time. Dust particles can build up on the GRILLE. See PAGE 19 for care and cleaning instructions.

Q: What is CFM?

A: CFM is a measurement of air movement (cubic feet per minute). The higher the CFM, the more air movement.

Q: What is a Sone?

A: Sone is the rating used to describe the sound level. The lower the Sone the quieter the fan.

Q: Can I install my bathroom ventilation FAN directly over a bathtub or shower?

A: Yes, but your FAN must be on a GFCI protected breaker. You must also use or consult a qualified licensed electrician.

Q: Do I have to vent my FAN to the outside?

A: Yes. All spot ventilation fans must be vented to the outside. Follow your local code and consult it for advice. See PAGE 6 for national venting installation suggestions and guidelines.

Q: Why do the windows and mirrors fog even when the FAN is running?

A: If windows and mirrors are very cold, condensation can still form on those surfaces. If the bathroom is sealed tightly, replacement air may not be entering the room fast enough to displace moist air. You need a gap under the bathroom entrance door to allow air to enter the bathroom. FAN placement may also be a factor. Additionally, your vent pipe must be a short run (see PAGE 6) and vented to the outside. Lastly, check to see if your vent pipe is blocked; if it is, the FAN cannot push air outside to dry the room.

Q: My fan is operating, but the air is moving slower than normal?

A: Check the GRILLE for buildup and clean if needed (see PAGE 19) or check for obstructions in ductwork. A common problem is debris in the roof cap.

Q: Why is there water dripping from my GRILLE?

A: Dripping water is either condensation (usually due to cold ductwork or improper duct installation), or a problem with the seal on the roof vent. Insulating the ductwork and fan housing can help solve condensation problems. Running the FAN longer will ensure moisture is completely removed from the duct.

Q: My FAN sounds louder than normal, what's going on?

A: Most likely, either the GRILLE is vibrating or it needs to be cleaned. See PAGE 19 for cleaning instructions. To check the GRILLE for vibration: Sometimes simply moving the GRILLE or taking it off and putting it back on will solve this issue.

Q: My FAN will not work, what do I do?

A: First, check the power. Is the breaker on? Having no power is the most common reason why the FAN will stop working. Next, check to make sure the wiring is correct, this is the second most common reason why the FAN won't work. Be safe, consult a qualified licensed electrician!

# 3-Year Limited Warranty

GTR Technologies Inc. (GTR) warrants to the original purchaser of its products that such products will be free from defects in materials and workmanship for a period of three years from the date of original purchase. There are no other warranties, express or implied, including but not limited to, implied warranties of merchantability or fitness for a particular purpose.

During this three-year period, GTR will, at its option, repair or replace, without charge, any product or part which is found to be defective under normal use and service. This warranty does not extend to lighting such as LED's, Fluorescent, Incandescent, tubes, starters or bulbs.

This warranty does not cover:

- (a) normal maintenance and service or
- (b) any maintenance or repair, faulty installation or installation contrary to recommended installation instructions.

The duration of any implied warranty is limited to the three-year period as specified for the express warranty. Some areas do not allow limitation on how long an implied warranty lasts, so the above limitation may not apply to you.

GTR's obligation to repair or replace, at GTR's option, shall be the purchaser's sole and exclusive remedy under this warranty. GTR shall not be liable for incidental, consequential, or special damages arising out of or in connection with product use or performance. Some areas do not allow the exclusion or limitation of incidental or consequential damages, so the above limitation may not apply to you.

This warranty gives you specific legal rights, and you may also have other rights, which vary from area to area.

This warranty supersedes all prior warranties.

This warranty is only valid inside the boundaries of the USA and Canada.

To qualify for warranty service, you must:

- (a) notify GTR via phone at 1-877-543-8698 (English) or 1-800-615-5439 (French) or via email at [info@reventfans.com](mailto:info@reventfans.com),
- (b) give the model number identification, and
- (c) describe the nature or any defect in the product or part.

At the time of requesting warranty service, you must provide evidence of the original purchase receipt.

GTR Technologies Inc.  
[www.reventfans.com](http://www.reventfans.com)

**Need Help?**  
**Watch the installation video at:**  
**[reventfans.com/install](http://reventfans.com/install)**

**Questions? Call**  
**1-877-543-8698 (English) or**  
**1-800-615-5439 (French)**  
**[info@reventfans.com](mailto:info@reventfans.com)**

ReVent and DewStop are products of GTR Technologies Inc. All rights reserved.  
USA and international patents pending.  
PART# RVP-100-WH-01 R1.0 120718